

**Approval data for pressure switches type E1S\*/E1H\*\*/MSPS\***

Approval:  II 1 G Ex ia IIB T6

Certificate no.: ISSeP08ATEX016X

Permissible ambient temperature: -40 °C ... +75 °C

Electrical data for intrinsically safe application: Ui = 28V li = 50 mA  
Ci = 40 pF Li = 4 µH

Standards applied: IEC 60079-0, IEC 60079-11, IEC 60079-26, IEC 61241-0 and IEC 61241-11

**Approval data for pressure switches type P1H/P1X**

Approval:  II 1 G D Ex ia IIC T6 Ex ia D 20 T100 **UL/CSA**

Certificate no.: ISSeP08ATEX016X **UL:**  
Class I, Div. 2 Group C&D  
Class II, Group E, F, G (not available on 1600 psi range)

Permissible ambient temperature: -40 °C ... +75 °C **CSA:**  
Class 3238-01,  
File No. 022345-0-000 (not approved with hermetical sealed limit switch)

Electrical data for intrinsically safe application: Ui = 28V li = 50 mA  
Ci = 40 pF Li = 4 µH

Standards applied: IEC 60079-0, IEC 60079-11, IEC 60079-26, IEC 61241-0 and IEC 61241-11

\* For hazardous areas this model must be installed inside an enclosure.

\*\* E1H with metal fitting and metal lid:

Approval:  II 1 G Ex ia IIC T6

**Operating life time**

Normal expected service life (expressed in the number of cycles over the full adjustment range) is appr. 1 million for the pressure switch. This may be extended to 2.5 million cycles max. if only a part of the adjustment range is used (about 20%).

Switch sensor life may also be effected negatively by:

- Media not compatible with the wetted materials.
- Too high switch cycling speed or more than 20 cycles per minute.
- System cycling pressure exceeding the top of the adjustable range.

The proof pressure must never be exceeded, otherwise the switch may be damaged. Careful selection of the pressure range can have a positive effect on the service life of the switch.

**Operating Instructions**

**Diaphragm Seal Piston Pressure Switches Type E1S/E1H/P1H/P1X/MPSP**



<b>1</b>	<b>Intended Applications .....</b>	<b>2</b>
<b>2</b>	<b>Safety Instructions.....</b>	<b>2</b>
<b>3</b>	<b>Standards .....</b>	<b>3</b>
<b>4</b>	<b>Warranty/Guaranty.....</b>	<b>3</b>
<b>5</b>	<b>Transport/Storage.....</b>	<b>3</b>
<b>6</b>	<b>Installation/Commissioning .....</b>	<b>4</b>
<b>7</b>	<b>Maintenance/Cleaning .....</b>	<b>7</b>
<b>8</b>	<b>Technical Data.....</b>	<b>8</b>

**Barksdale GmbH**  
Dorn-Assenheimer Straße 27  
D-61203 Reichelsheim

Phone: +49 (6035) 949-0  
Fax: +49 (6035) 949-111 and 949-113  
email: info@barksdale.de  
Internet: www.barksdale.de

Art. No.: 923-0167  
Index K, 08.04.2009



Specifications are subject to changes without notice!

### Intended Applications

The pressure switches are specifically applied for monitoring and controlling of operations using maximum and minimum pressures. A micro switch triggers an electrical signal when minimum or maximum pressure are reached.

 <b>DANGER</b>
<p>The switch may only be used in the specified fields of application (see type label).</p> <p>The temperature has to be within the specified ranges, the pressure values and the electrical rating must not exceed the values specified.</p> <p>Observe also the applicable national safety instructions for assembly, commissioning and operation of the switch.</p> <p>The switch is not designed to be used as the only safety relevant element in pressurized systems according to DGR 97/23/EC.</p> <p>Without special provisions/actions, pressure switches must not be used for pure gas or hydrogen applications.</p>

### Safety Instructions

The safety instructions are intended to protect the user from dangerous situations and/or material damage.

In the operating instructions the seriousness of the potential risk is designated by the following signal words:

 <b>DANGER</b>
<p>Refers to imminent danger to men.</p> <p>Nonobservance may result in fatal injuries.</p>

 <b>WARNING</b>
<p>Refers to a recognizable danger.</p> <p>Nonobservance may result in fatal injuries, and destroy the equipment or plant parts.</p>

 <b>CAUTION</b>
<p>Refers to a danger.</p> <p>Nonobservance may result in light injuries and material damage to the equipment and/or to the plant.</p>

	<b>IMPORTANT</b>
Refers to important information essential to the user.	

	<b>Disposal</b>
<p>The equipment must be disposed of correctly in accordance with the local regulations for electric/electronic equipment.</p> <p>The equipment must not be disposed of with the household garbage!</p>	

### Standards

The standards applied during development, manufacture and configuration are listed in the CE conformity and manufacturer's declaration.

### Warranty/Guaranty

#### Warranty

Our scope of delivery and services is governed by the legal warranties and warranty periods.

#### Terms of guaranty

We guaranty for function and material of the single- / dual- pressure switch under normal operating and maintenance conditions in accordance with the statutory provisions.

#### Loss of guaranty

The agreed guaranty period will expire in case of:

- changes or modifications to the switch/housing/fitting
- incorrect use,
- incorrect installation or
- incorrect handling or operation contrary to the provisions of these operating instructions.

No liability is assumed for any damage resulting therefrom, or any consequential damage.

### Transport/Storage

 <b>CAUTION</b>
Severe shock and vibrations should be avoided during transport. Storage should be dry and clean.

### Installation/Commissioning

<b>DANGER</b>
<p>Only install or uninstall the switch when deenergized (electrically and hydraulically/pneumatically).</p> <p>Pressure connection and electrical connection must be carried out by trained or instructed personnel according to state-of-the-art standards.</p> <p>The switch must only be installed in systems where the maximum pressure <math>P_{max}</math> is not exceeded (see type label).</p>

<b>CAUTION</b>
<p>Alternating pressure - vacuum applications are not authorized in switch types which are suitable for both vacuum and pressure applications.</p>

<b>WARNING</b>
<p>Pressure peaks and pressure shocks exceeding the maximum operating pressure are inadmissible.</p> <p>The maximum operating pressure is the upper final value of the adjustable range or, if specified, the pressure indicated as maximum operating pressure. Exceeding the max. operating pressure affects the performance and the life span of the product and may damage it.</p> <p>Pressure switches must be mounted vibrationless.</p>

<b>WARNING</b>
<p>Check the switch regularly for functioning.</p> <p>If the switch does not work properly, stop operation immediately!</p>

<b>IMPORTANT</b>
<p>All pressure switches are tested for proper functioning before they leave the factory.</p> <p>The factory proof pressures are stated on the type plate.</p>

#### Contact Protection

The micro switches used are normally suitable for both direct and alternating current operation. Inductive, capacitive and lamp loads may, however, considerably reduce the life expectancy of a micro switch and, under extreme circumstances, even damage the contacts.

Depending on the application spark suppression and current limiting is recommended (see succeeding figures).

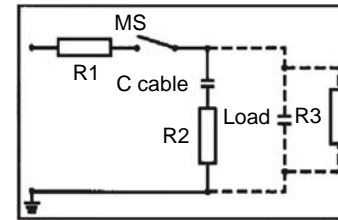

Fig. 1: Protection in case of capacitive loads  
R1: Protection against starting current  
rushes R2,R3: Protection against high discharge currents

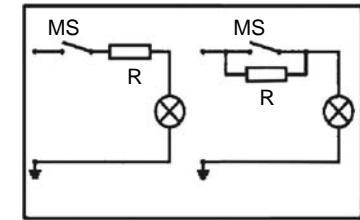

Fig. 2: Lamp load provided with resistance in parallel or series connection to switch of condensators

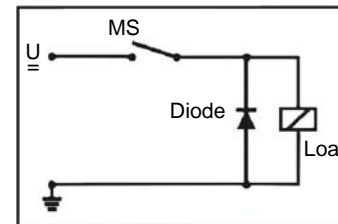

Fig. 3: Protection in case of continuous current and inductive load by recovery diode

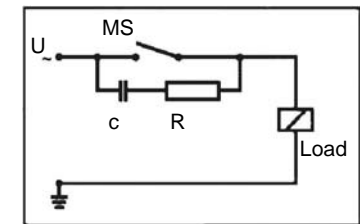

Fig. 4: Protection in case of alternating current and inductive load by RC-link

#### Set point adjustment

<b>IMPORTANT</b>
<p>Factory-Provided: pressure (temperature) switch point setting We confirm for pressure (temperature) switches that have been factory set the setting will be detailed on the label name plate.</p> <p>Warranty is not applicable for any changes that may occur due to transportation or installation. For critical applications we recommend the setting is checked and re-set if necessary after installation and wiring of the pressure (temperature) switch.</p>

In pressure switches, a displacement of the pressure sensing element occurs with a change in pressure. Following the displacement of the pressure sensing element operates a microswitch.

Upon delivery of the product, the set points are likely to be found in the middle of the adjustable range. On request, fix set points may be adjusted by our factory. In this event, the point will be indicated on the type plate or any separate plate, i = increasing, d = decreasing.

The set point is adjusted by turning the adjustment screw.

**IMPORTANT**  
To reach the adjustment screw for pressure switches with housing, remove the cover (see figure 7 ... 11).

- Allow pressure switch to reach the desired switch pressure.
- Turn adjustment screw clockwise or counterclockwise to actuate the micro switch.

**IMPORTANT**  
Please consult the wiring diagram for the contact status at atmospheric pressure (see Fig. 5).

**IMPORTANT**  
Particularly important for small pressures! Set point adjustment must be performed in installation position.

**Precise adjustment of set point to actuate on increasing pressure**

- Lower system pressure to 0 bar.
- Increase pressure slowly and check if micro switch is actuated at desired switch pressure.
- If necessary, readjust by turning the adjustment screw
- Repeat preceding steps until microswitch operates at desired switch pressure.

**Precise adjustment of set point to actuate on decreasing pressure**

- Increase pressure up to a point clearly above the desired switch pressure (at least, switch pressure plus max. hysteresis; not above max. operating pressure).
- Lower pressure slowly and check if micro switch is actuated at desired switch pressure.
- If necessary, readjust by turning the adjustment screw
- Repeat preceding steps until microswitch operates at desired switch pressure.
- Following the adjustment of all set points, each set point must be checked and, if necessary, be readjusted.

**IMPORTANT**  
The adjustment of several set points occurs for each set point as specified above.

**Wiring Code for all Types** (Contact status at atm. pressure)



Fig. 5: Wiring Code

**Use in Hazardous Locations**

The pressure switches with optional EEx ia are approved for applications in hazardous locations for intrinsically safe circuits according to ATEX regulations. They must be operated with a switch amplifier (see Fig. 6).

- They are only for use in an approved intrinsically safe circuit.
- Units with explosion-proof enclosures must be operated in accordance with their approval.

Approval class and identification characteristics according to type plate information must always be observed. The models having light-alloy (aluminium) enclosures or enclosure parts must be protected against all impact or friction which can ignite the explosive atmosphere. EC-design approved types are marked with a label according to ATEX 94/9/EC.

- The wiring between switch and Ex i isolation amplifier must meet the local safety requirements.
- The customer must provide for a highly conductive connection between switch and grounding.

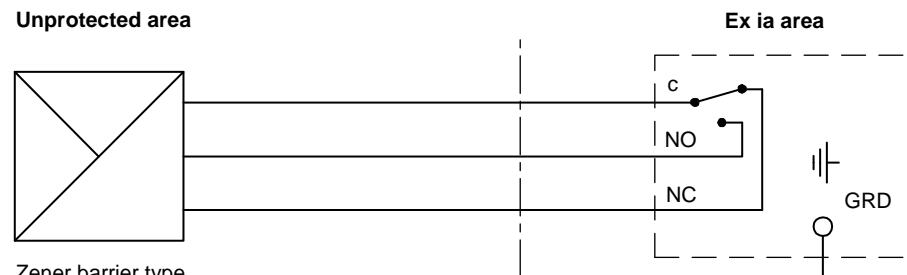

Zener barrier type  
Switch amplifier NAMUR

Fig. 6: Operation of pressure switches in intrinsically safe areas

**Maintenance/Cleaning**

**Maintenance**

The pressure switch is maintenance free. Checking the set points lies within the discretion of the user. The usual preventive maintenance work in accordance with the PED and ATEX guidelines must always be carried out.

Please note that small setpoint drifts may occur during the initial use of the switch (run-in period). To minimize the setpoint drift we can perform a run-in (ageing) process in our works on request. Larger or continuing setpoint drifts during the normal use of the switch may indicate that the measuring system is not used correctly within the specified limits, exceeding the design criteria or is worn-out. This might lead to metal fatigue of the measuring system and it therefore should be replaced before an ultimate rupture of the metal diaphragm might take place. Please consult your supplier or Barksdale directly for guidelines.

**Technical Data**

See data sheet

**Dimensions** in mm (inch)

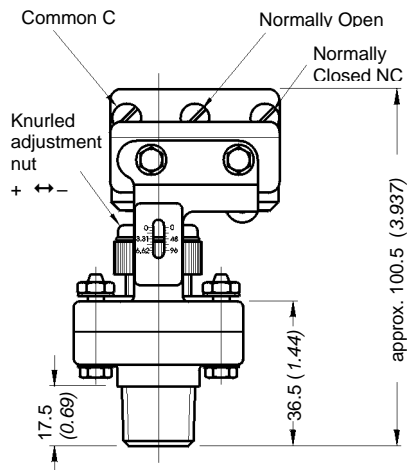

Fig. 7: Diaphragm seal piston pressure switch type E1S-...

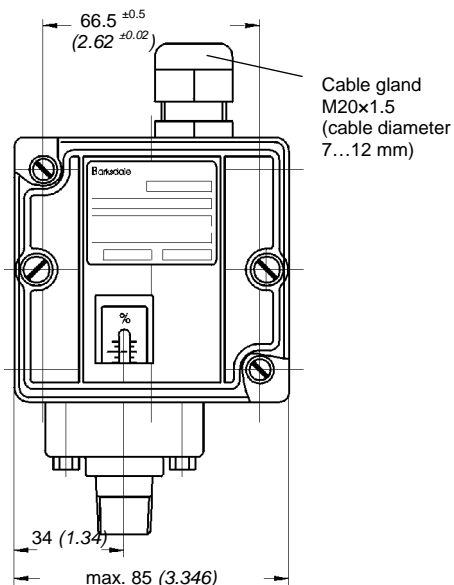

Fig. 8: Diaphragm seal piston pressure switch type E1H-...

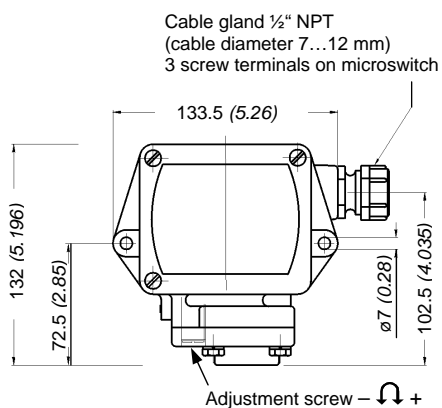

Fig. 9: Diaphragm seal piston pressure switch type P1H-...

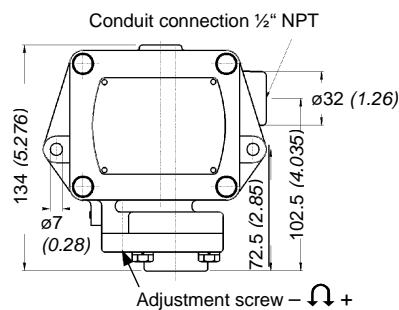

Fig. 10: Diaphragm seal piston pressure switch type P1X-...

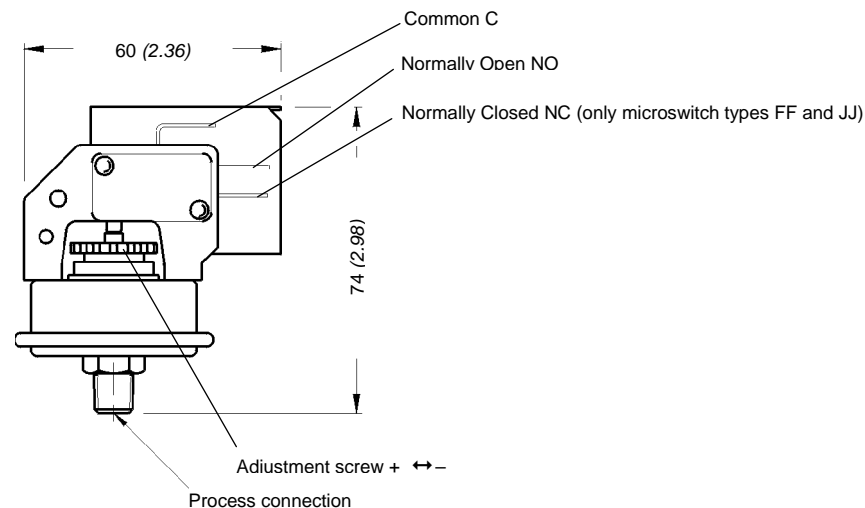

Fig. 11: Diaphragm seal piston pressure switch type MSPS-...

**Adjustable Ranges Pressure Switch Type MSPS...**

Pressure range code	Adjustable range [bar]		Max. operation pressure [bar]	Proof pressure [bar] (short term)	Max. hysteresis of switch types (end of range)	
	Increasing pressure	Decreasing pressure			EE, FF [bar]	DD, JJ [bar]
5SS	0.1 0.34	0.04 0.305	4.6	6.9	0.035	0.040
15SS	0.2 1.00	0.10 0.900	4.6	6.9	0.055	0.068
500SS	1.2 6.80	0.70 6.300	6.8	10.0	0.540	0.620

**Electrical Ratings Pressure Switch Type MSPS...**

Micro switch	Special Characteristics	Volt AC 50/60 Hz	Ind. Load A	Res. Load A	Volt DC	Ind. Load A	Res. Load A	Notes
EE, FF	Microswitch with silver contacts	125 250	3	3	---	---	---	Medium hysteresis; high AC loads
DD, JJ			15	15	125 250	0.50 0.25	0.50 0.25	

**Adjustable Ranges Pressure Switches Type E1S.../E1H...**

Pressure range code	Adjustable range [bar] Differential pressure		Max. operating pressure [bar]	Proof pressure* [bar]	Max. hysteresis of switch types (end of range)	
	Increasing pressure	Decreasing pressure			(short term)	H, GH [bar]
Overpressure						
<b>15</b>	0.10 ...1.0	0.04 ...1.00	46	30/70	0.08	0.080
<b>90</b>	0.80 ...6.0	0.20 ...5.00	46	30/70	0.55	0.680
<b>250</b>	2.10 ...17.0	0.70 ...16.00	46	30/70	1.37	1.440
<b>500</b>	3.70 ...34.0	1.72 ...32.00	46	30/70	1.93	2.750
<b>Vacuum</b>						
<b>VAC</b>	-0.28 ...-0.9	-0.20 ...-0.82	2.0	-1.0	0.08	0.077

\* **Note:** designed for 70 bar proof pressure! For reasons of manufacturing technology only a proof pressure of 30 bar is applied!

**Electrical Ratings Pressure Switch Type E1S.../E1H...**

Micro switch	Special Characteristics	Volt AC 50/60 Hz	Ind. Load A	Res. Load A	Volt DC	Ind. Load A	Res. Load A	Notes
<b>H</b>	Microswitch with silver contacts	125 250	10 10	10 10	6 to 24	0,50	0,5	Small hysteresis; high AC / low DC loads
<b>M</b>	Microswitch with silver contacts	125 250	10 10	10 10	12 24 250	5,00 1,00 0,25	15,0 2,0 0,4	Medium hysteresis; high AC and DC loads
<b>GH</b>	Microswitch with gold plated contacts for low voltage and low current	125	1	1	24	1,00	1,00	low change-back values
<b>GM</b>		30	0.1	0.1	30	0,10	0,10	Medium hysteresis

 <b>IMPORTANT</b>
We recommend to use a prefuse of the maximum current rating from the table above according to the load switched.
We recommend gold plated contacts for all intrinsically safe and other applications with low voltage/power.

**Adjustable Ranges Pressure Switches Type P1H.../P1X...**

Pressure range code	Adjustable range [bar] Differential pressure		Max. operation pressure [bar]	Proof pressure [bar]	Max. hysteresis of switch types (end of range)		
	Increasing pressure	Decreasing pressure			(short term)	B [bar]	H, GH [bar]
<b>30</b>	0.1 ...2.1	0.03 ...2.0	91	137	0.14	0.06	0.17
<b>85</b>	0.4 ...6.0	0.20 ...5.8	91	137	0.50	0.17	0.58
<b>340</b>	0.8 ...23.4	0.40 ...23.0	91	137	1.50	0.41	1.83
<b>600</b>	2.9 ...41.0	1.70 ...40.0	91	137	2.00	1.17	2.42
<b>1600</b>	32.0 ...107.0	28.0 ...101.0	110	165	6.80	4.8	8.6

**Electrical Ratings Pressure Switches Type P1H.../P1X...**

Micro switch	Special Characteristics	Volt AC 50/60 Hz	Ind. Load A	Res. Load A	Volt DC	Ind. Load A	Res. Load A	Notes
<b>H</b>	Microswitch with silver contacts	125 250 480	10 10 3	10 10 3	6 to 24	0,50	0,5	Small hysteresis; high AC / low DC loads
<b>GH</b>	Microswitch with gold plated contacts for low voltage and low current	125	1	1	24	1,00	1,00	low change-back values
<b>K, B</b>	Microswitch with silver contacts  K: with sealed plunger and stainless steel blade	125 250 480	10 10 3	10 10 3	12 24 250	5,00 1,00 0,25	15,0 2,0 0,4	Medium hysteresis; high AC and DC loads

 <b>IMPORTANT</b>
We recommend to use a prefuse of the maximum current rating from the table above according to the load switched.
We recommend gold plated contacts for all intrinsically safe and other applications with low voltage/power.